

# Installation Manual



## 10165 KIT

Toyota Tacoma (4WD)\*

*Use the most advanced air springs on the market to eliminate your vehicle's sag, sway and bottoming out. This heavy duty air suspension kit levels your truck's stance while providing added support for an overall smooth and safe ride.*

\* See application guide for proper fitment.

L6173\_REV7\_10.26.2020



**WARNING:** This product can expose you to the chemical Hexavalent Chromate, which is known to the State of California to cause cancer and birth defects or other reproductive harm. *For more information go to [www.P65Warnings.ca.gov](http://www.P65Warnings.ca.gov)*

## HP10165 - KIT LAYOUT

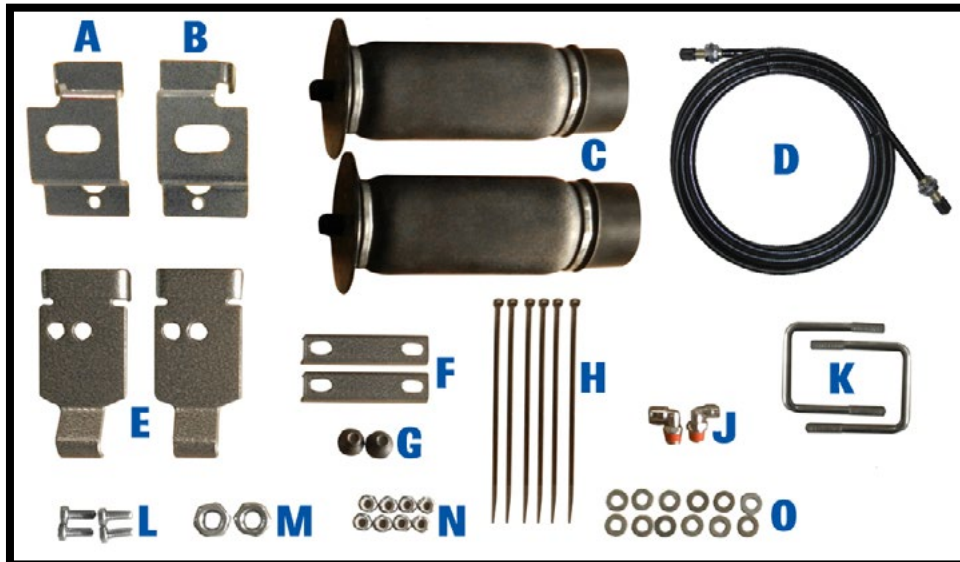

### CAUTION:

This kit includes “push to connect OR barbed” air line fittings. They require the end of the air line to be round, square and cleanly cut to ensure the internal seal will not leak. The air line must only be cut with a sharp razor knife or a hose cutter.

### NOTE:

Do not apply air pressure to the air spring until advised to in Step 9.

Make sure all the items shown in the photo are provided in your kit before starting the installation.

### KIT CONTENTS

<b>A</b>	Upper Bracket, Left (1)	HP1296
<b>B</b>	Upper Bracket, Right (1)	HP1297
<b>C</b>	Air Spring (2)	HP10199
<b>D</b>	Air Line / Valve Assembly	HP1344
<b>E</b>	Lower Bracket (2)	HP1298
<b>F</b>	U-Bolt Clamp Bars (2)	HP0113
<b>G</b>	Countersunk Cap Screw, 1/2" - 13 x 3/4"	HP1342
<b>H</b>	Tie Strap (6)	C11618
<b>J</b>	Air Fitting, 90°, Swivel (2)	HP1019
<b>K</b>	U-Bolt, 3/8" x 3" x 3-3/4"	HP1018
<b>L</b>	Bolt, 3/8" -16 x 1" (4)	C18005
<b>M</b>	Nut, Jam, 3/4" - 16 (2)	HP1076
<b>N</b>	Nut, Nyloc, 3/8" -16 (8)	HP1000
<b>O</b>	Washer, Flat, 3/8" (12)	C653
		HP1297

### REQUIRED TOOLS

- 7/16", 1/2", 9/16" Open End or Box Wrenches
- 1/18" Open End Wrench
- 9/16" & 13mm Deep Well Sockets
- Torque Wrench
- Cut Off Wheel or Sawzall / Hack Saw
- Pipe Thread Sealant
- Hose Cutter, Razor Blade or sharp Knife
- Air Compressor/Compressed Air Source
- Hoist or Floor Jack
- Safety Stands
- Safety Glasses
- Spray Bottle with Dish Soap/Water Solution

Thank you and congratulations on the purchase of an air suspension kit. Please read the entire installation manual prior to starting the installation to ensure you can complete the installation once started.

**IMPORTANT:**

This air suspension kit will not increase the GVWR (Gross Vehicle Weight Rating), as the GVWR is determined by the axle rating. Do not exceed the maximum capacity listed by the vehicle manufacturer.

**NOTE:**

Some vehicles are equipped with a real brake proportioning valve. Check this with the manufacturer before installing the air spring kit, as it may affect braking performance.

**BEFORE STARTING:**

1. Ensure the application information is correct for the make, model and year of the vehicle you are installing the kit on.
2. Check the vehicle to see if it is equipped with a 5th wheel hitch. Some 5th wheel hitches require brackets to be mounted in the frame in the same locations as the air spring brackets. (If this is the case, you may need a different air spring kit. Please contact 800-663-0096.)
3. Check the clearance between the outside of the frame and the inside of the tire. A maximum of 6" is required for air spring clearance.
4. It is recommended to use a good quality anti-seize on all fasteners. This will reduce the chance of corrosion on the fasteners and will help facilitate removal, if required at a later date.

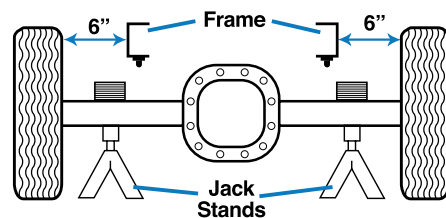

## 1. ASSEMBLE THE UPPER BRACKET TO EACH AIR SPRING

Determine which air spring will be installed on the driver side of the vehicle with the other air spring to be installed on the passenger side. Fasten the proper upper bracket to each air spring in the proper position, leaving loose for later adjustment.

Loosely attach the left upper bracket to the air spring for the driver side with the 3/4" -16 jam nut (A), as shown. (The jam nut will be securely fastened in **step 9**.)

Loosely attach the right upper bracket to the air spring for the passenger side with the other 3/4" -16 jam nut (B), as shown. (The jam nut will be securely fastened in **step 9**.)

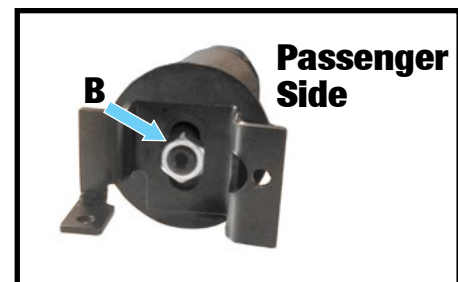
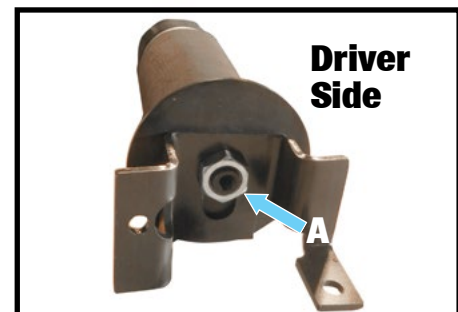

## 2. ASSEMBLE A LOWER BRACKET TO EACH AIR SPRING

Securely fasten a lower bracket to each air spring, making sure the lower bracket is positioned properly.

Attach a lower bracket to the air spring for the driver side with the 1/2" -13 x 3/4" countersunk cap screw (A). Make sure the lower bracket is positioned so that its side flanges are facing away from the air spring and the bolt is screwed into the **middle** opening of the lower bracket, as shown. Tighten to 25 ft-lbs, 34N·m.

Attach a lower bracket to the air spring for the passenger side with the 1/2" -13 x 3/4" countersunk cap screw (A). Make sure the lower bracket is positioned so that its side flanges are facing away from the air spring and the bolt is screwed into the **side** opening of the lower bracket, as shown. Tighten to 25 ft-lbs, 34N·m.

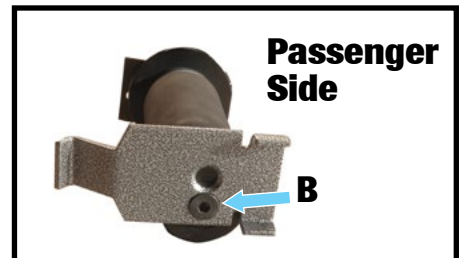
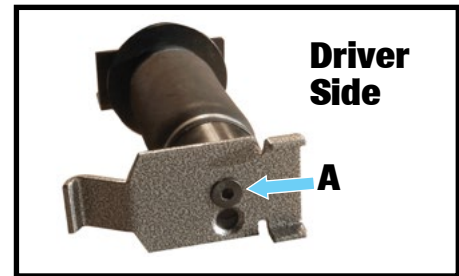

## 3. INSTALL AN AIR LINE FITTING TO EACH AIR SPRING

Install a 90° air line fitting (A) into the top of each air spring. Use thread sealant.

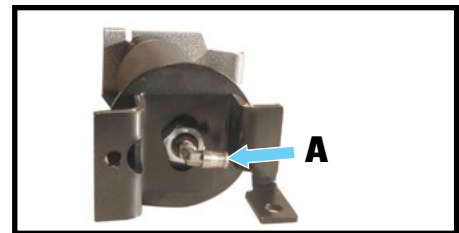

## 4. RAISE THE REAR AXLE

Remove any unnecessary weight from the vehicle to attain normal ride height. This is important for correct initial air spring setup and adjustment. Park the vehicle on a level concrete surface.

Record the vehicle's 'normal ride height', which is the distance between the center of the axle and the horizontal wheel well flange. Ensure both sides are the same before raising the vehicle. Raise the rear axle high enough to remove both rear wheels and attain a comfortable working height. Place two jack stands under the axle, as shown in the photo. Lower the floor jack until the vehicle axle is supported by the jack stands. Ensure the normal ride height measurement recorded earlier is the same. Adjust if necessary before proceeding.

Once the rear axle is raised correctly, remove the rear wheels.

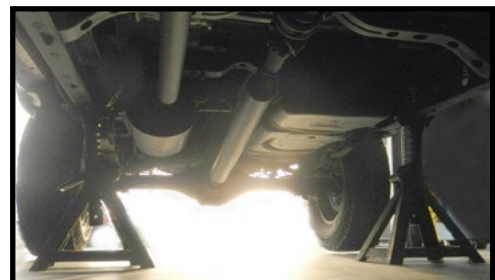

**NOTE:**

The following instructions are shown for the driver side of the vehicle.

**5. POSITION THE AIR SPRING AND BRACKETS**

Set the air spring assembly with the upper bracket holes aligned with the existing holes in the frame and the lower bracket positioned on the leaf spring forward of the axle.

Ensure that the holes in the upper bracket align with the holes on the bottom (A) and side (B) surfaces of the frame bar.

Set the holes on the upper flange and side flange of the upper bracket to align with the holes on the frame bar, as shown. Set the lower bracket on the leaf spring so its curved part (C) is over the axle U-bolt, as shown. The air spring should then be positioned as shown. Ensure that the 90° air line fitting (D) is pointing outward.

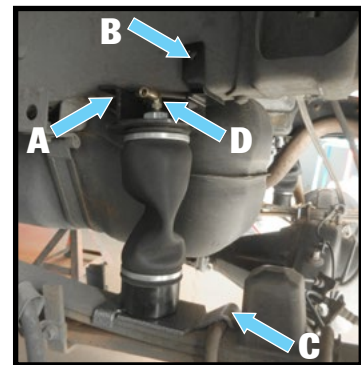
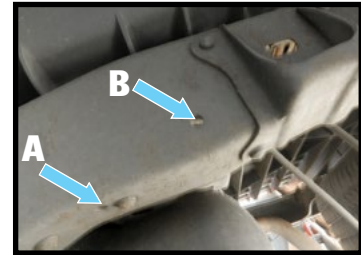
**6. SECURE THE UPPER BRACKET TO THE FRAME**

Attach the upper bracket to the frame bar at the bracket's top (A) and side (B) flanges, as shown, with a 1/2" -13 x 3/4" tapered head bolt, two 3/8" washers and a 3/8" -16 nylock nut. Tighten to 25 ft-lbs, 34N·m.

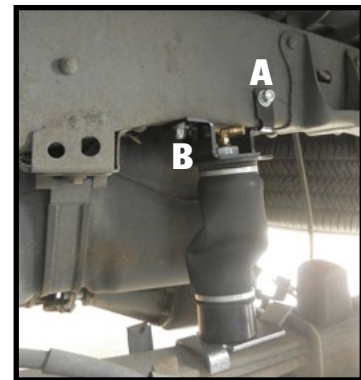
**7. SECURE THE LOWER BRACKET TO THE LEAF SPRING**

Secure the lower bracket to the leaf spring with a U-bolt, as shown. Slide a clamp bar (A) on the U-bolt and secure each side with a 3/8" washer and 3/8" nylock nut. Tighten to 25 ft-lbs, 34N·m.

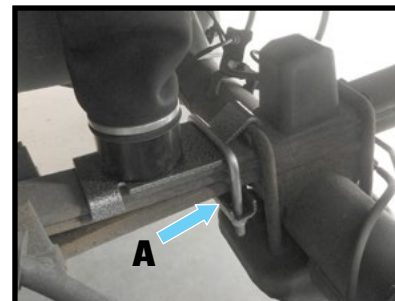

## 8. INSTALL THE AIR LINE

Provided in the basic air spring kit are two fill valves, the most common place to install them is to replace the license plate fasteners with the fill valves (A). Alternatively, two holes can be drilled in a convenient location. Install one airline provided, route the nylon hose to an air spring fitting, cut the hose and connect to the air spring fitting. Repeat with the other fill valve. Secure airlines with the tie-straps provided away from moving items and heat sources.

If an in cab inflation kit is being installed, follow the instructions provided with it.

NOTE: This kit contains push to connect fittings, using scissors or wire cutters to cut the nylon airline will distort the line and cause the connection to leak. **THE AIRLINE MUST BE CUT OFF SQUARELY WITH A SHARP RAZOR KNIFE.** Moisten the end of the airline prior to inserting it into the fitting and push it in until it stops.

After the air line is cut, insert one end into the air line fitting, as shown in (B), and the other into the fill valve. Moisten the end of the air line with liquid soap prior to inserting it, and then push it in until it stops

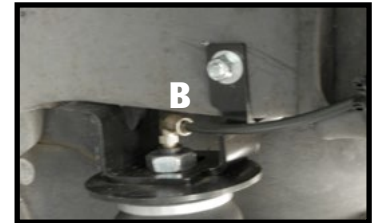
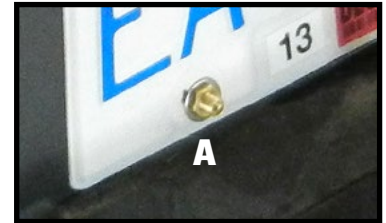

## 9. ALIGN, THEN TIGHTEN THE JAM NUT SECURING THE AIR SPRING TO THE UPPER BRACKET

Make sure the jam nut (A) is positioned properly on the upper bracket: on the driver side it should be on the outer edge of the slot, on the passenger side it should be approximately in the center. Adjust as necessary.

Then, tightly secure the jam nut. Tighten to 25 ft-lbs, 34N·m. For stability, inflate the air spring to 10 PSI.

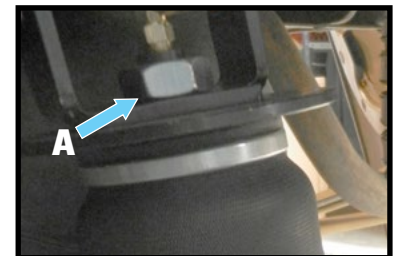

**REPEAT STEPS 5 – 9 ON THE OTHER SIDE OF THE VEHICLE.**

## 10. DO A LEAK CHECK

Inflate both the air springs to 90 PSI, then use a dish soap and water mixture on all air line connections to detect any air leaks. Repair as necessary and retest.

Inflate the air springs to a predetermined value, and on the following day recheck the pressure. If one or both the air springs have lost pressure, a leak is present. The leak must be repaired, and then retested until no leaks exist.



## 11. AFTER THE INSTALLATION IS COMPLETED:

Install the wheels, torquing the fasteners to the manufacturer's specifications.

Re-torque all the fasteners after the first 500 miles of driving.

.....

***Thank you again, and congratulations on the installation of the air suspension kit.***

### OPTIONAL ACCESSORIES

Optional dual needle air gauges are available to monitor pressure in each spring from vehicle cab, as well as a full line of air compressors, air tanks, and solenoids built to work with and control your air spring system.

### OPERATING YOUR VEHICLE WITH AIR SUSPENSION

Air springs have minimum and maximum pressure requirements. Never operate your vehicle with less than 10 psi in air spring and never inflate air springs over 100 psi. Damage to air springs will result.

Check air pressure in air springs daily for first couple of days to ensure a leak has not developed. Air springs are designed to maintain the vehicles stock ride height with a load. Do not use the air springs as a means to lift vehicle with no load. This will result in a harsh ride.

### SERVICING YOUR VEHICLE WITH AIR SUSPENSION

When lifting the vehicle with a floor jack or hoist on the frame, never allow the air spring to limit the travel of the axle. Try to always jack the vehicle on the axle. Suspending the axle with the air spring limiting the axle travel will damage the air spring and void the air spring warranty.

### WARRANTY

To be eligible for warranty, the owner must submit their warranty card or register online within 30 days of the purchase date.

***NOTE: The owner's warranty will be void if air springs are run with less than the minimum of 10 psi.***

.....